

# Data Sheet



Article number: 071131400420060

Description: Cardan drive shaft 0.113.140.001  
S=420 X=60 Bore with keyway

## Measures

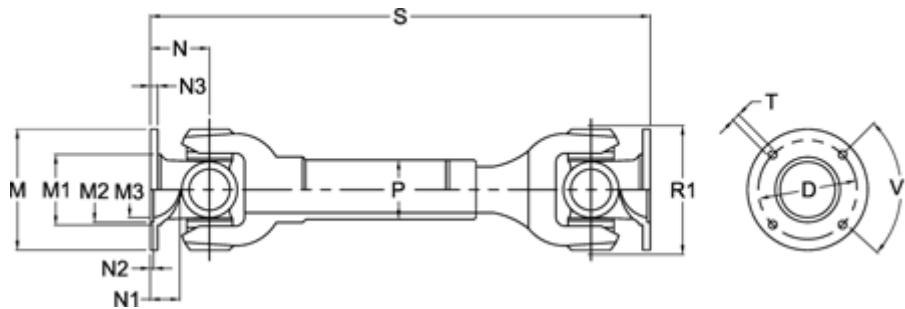

D	= 101,5 +-0,1	N1	= 27.5	T	= 10 B12
Extension X	= 60	N2	= 2,5 +0,5	V1 degrees	= 45
Flange diameter M	= 120	N3	= 9		
M1	= 80.5	Number of Flangeholes	= 8		
M2	= 75	P	= 70x4		
M3	= 69	R1	= 125		
Max. Bending Angle degrees	= 20	S min	= 420		
N	= 60	Spline dim. DIN 5480	= 50x2x24		